

Installation Manual

NAVIGATION AV SYSTEM

AVIC-F80DAB
AVIC-F980DAB

01 Precautions

- Your new product and this manual **3**
- Important safeguards **3**

02 Connection

- Precautions before connecting the system **5**
- Before installing this product **5**
- To prevent damage **6**
 - Notice for the blue/white lead **6**
- Parts supplied **7**
- Connecting the power cord (1) **8**
- Connecting the power cord (2) **10**
- Connecting the system **12**
- Connecting to separately sold power amp **13**
- Connecting an iPod / iPhone or an Android device **14**
- Connecting an iPhone with Lightning connector **15**
 - Connecting via the USB port (iPhone) **15**
 - Connecting via the HDMI port (iPhone) **15**
- Connecting an iPhone with 30-pin connector **16**
 - Connecting via the AUX input (iPhone) **16**
 - Connecting via the RGB input (iPhone) **16**
- Connecting the Android™ device **17**
 - Connecting via the HDMI port (Android device) **17**
 - Connecting via the MHL port (Android device) **17**
- Connecting via the USB port (Android device) **18**
- Securing the High Speed HDMI® Cable **18**
- Connecting a rear view camera **19**

Connecting the external video component **20**

- Using AV input **20**
- Using an AUX input **21**

Connecting an HDMI device **22**

Connecting the rear display **22**

- When using a rear display connected to rear video output **22**

03 Installation

- Precautions before installation **23**
- To avoid electromagnetic interference **23**
- Before installing **23**
 - For AVIC-F80DAB users **24**
- Installing this product **24**
 - Installation notes **24**
 - Parts supplied **25**
 - Installation using the screw holes on the side of this product **25**
- Installing the GPS aerial **26**
 - Installation notes **26**
 - When installing the aerial inside the vehicle (on the dashboard or rear shelf) **27**
- Installing the microphone **28**
 - Parts supplied **28**
 - Mounting on the sun visor **28**
 - Installation on the steering column **29**
 - Adjusting the microphone angle **29**

04 After installation

- After installing this product **30**

Precautions

Your new product and this manual

- The navigation features of this product (and the rear view camera option if purchased) are intended solely to aid you in the operation of your vehicle. It is not a substitute for your attentiveness, judgement and care when driving.
- Never use this product to route to hospitals, police stations, or similar facilities in an emergency. Please call the appropriate emergency number.
- Do not operate this product, any applications, or the rear view camera option (if purchased) if doing so will divert your attention in any way from the safe operation of your vehicle. Always observe safe driving rules and follow all existing traffic regulations. If you experience difficulty in operating this product or reading the display, park your vehicle in a safe location and apply the handbrake before making the necessary adjustments.
- This manual explains how to install this product in your vehicle. Operation of this product is explained in the separate manuals.
- Do not install this product where it may (i) obstruct the driver's vision, (ii) impair the performance of any of the vehicle's operating systems or safety features, including airbags, hazard lamp buttons, or (iii) impair the driver's ability to safely operate the vehicle. In some cases, it may not be possible to install this product because of the vehicle type or the shape of the vehicle interior.
- Model icons shown in this manual indicate that the description is intended for the models indicated by the icons. If the following icon is shown, the description is applied only to the model shown. e.g.)

F80DAB

- The graphical symbol  placed on the product means direct current. 

Important safeguards



WARNING

Pioneer does not recommend that you install this product yourself. This product is designed for professional installation only. We recommend that only authorised Pioneer service personnel, who have special training and experience in mobile electronics, set up and install this product. NEVER SERVICE THIS PRODUCT YOURSELF. Installing or servicing this product and its connecting cables may expose you to the risk of electric shock or other hazards, and can cause damage to this product that is not covered by warranty.

- Read this manual fully and carefully before installing this product.
- Keep this manual handy for future reference.
- Pay close attention to all warnings in this manual and follow the instructions carefully.
- This product may in certain circumstances display inaccurate position of your vehicle, the distance of objects shown on the screen, and compass directions. In addition, the system has certain limitations, including the inability to identify one-way streets, temporary traffic restrictions and potentially unsafe driving areas. Please exercise your own judgement in the light of actual driving conditions.
- As with any accessory in your vehicle's interior, this product should not divert your attention from the safe operation of your vehicle as it may result in serious injury or death. If you experience difficulty in operating the system or reading the display, please make adjustments while safely parked.
- Please remember to wear your seat belt at all times while operating your vehicle. If you are in an accident, your injuries can be considerably more severe if your seat belt is not properly fastened.

Precautions

- Certain country and government laws may prohibit or restrict the placement and use of this product in your vehicle. Please comply with all applicable laws and regulations regarding the use, installation and operation of this product. ▣

Connection

Precautions before connecting the system



WARNING

Do not take any steps to tamper with or disable the handbrake interlock system which is in place for your protection. Tampering with or disabling the handbrake interlock system could result in serious injury or death.



CAUTION

- If you decide to perform the installation yourself, and have special training and experience in the mobile electronics installations, please carefully follow all of the steps in the installation manual.
- Secure all wiring with cable clamps or electrical tape. Do not allow any bare wiring to remain exposed.
- Do not directly connect the yellow lead of this product to the vehicle battery. If the lead is directly connected to the battery, engine vibration may eventually cause the insulation to fail at the point where the wire passes from the passenger compartment into the engine compartment. If the yellow lead's insulation tears as a result of contact with metal parts, short-circuiting can occur, resulting in considerable danger.
- It is extremely dangerous to allow cables to become wound around the steering column or gearstick. Be sure to install this product, its cables, and wiring away in such so that they will not obstruct or hinder driving.
- Make sure that the cables and wires will not interfere with or become caught in any of the vehicle's moving parts, especially the steering wheel, gearstick, handbrake, sliding seat tracks, doors, or any of the vehicle's controls.
- Do not route wires where they will be exposed to high temperatures. If the insulation heats up, wires may become

damaged, resulting in a short circuit or malfunction and permanent damage to the product.

- Do not cut the GPS aerial cable to shorten it or use an extension to make it longer. Altering the aerial cable could result in a short circuit or malfunction.
- Do not shorten any leads. If you do, the protection circuit (fuse holder, fuse resistor or filter, etc.) may fail to work properly.
- Never feed power to other electronic products by cutting the insulation of the power supply lead of this product and taping into the lead. The current capacity of the lead will be exceeded, causing overheating. ▣

Before installing this product

- Use this product with a 12-volt battery and negative earthing only. Failure to do so may result in a fire or malfunction.
- To avoid shorts in the electrical system, be sure to disconnect the (-) battery cable before installation.

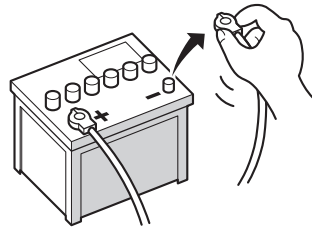

To prevent damage

! WARNING

- Use speakers over 50 W (maximum input power) and between 4 Ω to 8 Ω (impedance value). Do not use 1 Ω to 3 Ω speakers for this product.
- The black lead is earth. Please earth this lead separately from the earth of high-current products such as power amps. Do not earth more than one product together with the earth from another product. For example, you must separately earth any amp unit away from the earth of this product. Connecting earths together can cause a fire and/or damage the products if their earths became detached.
- When replacing the fuse, be sure to only use a fuse of the rating prescribed on this product.
 - When disconnecting a connector, pull the connector itself. Do not pull the lead, as you may pull it out of the connector.
 - This product cannot be installed in a vehicle without ACC (accessory) position on the ignition switch.



ACC position



No ACC position

- To avoid short-circuiting, cover the disconnected lead with insulating tape. It is especially important to insulate all unused speaker leads, which if left uncovered may cause a short circuit.
- Attach the connectors of the same colour to the corresponding coloured port, i.e., blue connector to the blue port, black to black, etc.
- Refer to the owner's manual for details on connecting the power amp and other units, then make connections accordingly.

- Since a unique BPTL circuit is employed, do not directly earth the ⊖ side of the speaker lead or connect the ⊖ side of another side of the speaker lead together. Be sure to connect the ⊖ side of the speaker lead to the ⊖ side of the speaker lead on this product.

Notice for the blue/white lead

! Important

When this product is in "Power OFF" mode, the control signal is also turned off. If "Power OFF" mode is cancelled, the control signal is output again and the aerial is extended with the auto aerial function (if the aerial is being used). Be careful so that the extended aerial does not come into contact with any obstacles.

- When the ignition switch is turned on (ACC ON), a control signal is output through the blue/white lead. Connect to an external power amp's system remote control terminal, the auto-aerial relay control terminal, or the aerial booster power control terminal (max. 300 mA 12VDC). The control signal is output through the blue/white lead, even if the audio source is switched off.
- Be sure not to use this lead as the power supply lead for the external power amps. Such connection could cause excessive current drain and malfunction.
- Be sure not to use this lead as the power supply lead for the auto-aerial or aerial booster. Such connection could cause excessive current drain and malfunction. ■

Connection

Parts supplied

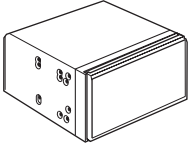

This product

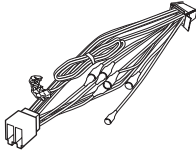

Power cord

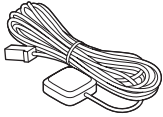

GPS aerial

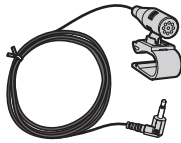

Microphone

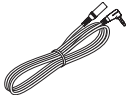

Mini-jack extension cable



USB cable

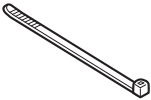

Lock tie

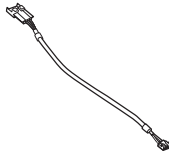

Vehicle Bus conversion cable



Metal sheet



Clamp (3 pcs.)



Double-sided tape



Connecting the power cord (1)



Note

Depending on the types of vehicles, the function of *2 and *4 may be different. In this case, be sure to connect *1 to *4 and *3 to *2 as shown in the figure.

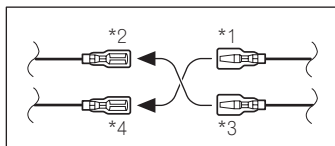

Connect leads of the same colour to each other.

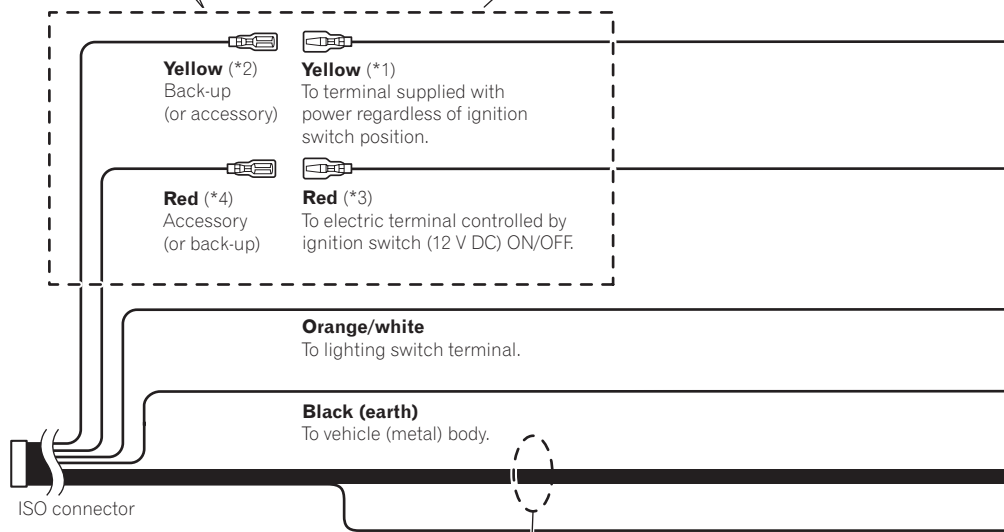

Note

In some vehicles, the ISO connector may be divided into two. In this case, be sure to connect to both connectors.

Speaker leads

- White: Front left ⊕
- White/black: Front left ⊖
- Grey: Front right ⊕
- Grey/black: Front right ⊖
- Green: Rear left ⊕
- Green/black: Rear left ⊖
- Violet: Rear right ⊕
- Violet/black: Rear right ⊖

Connection

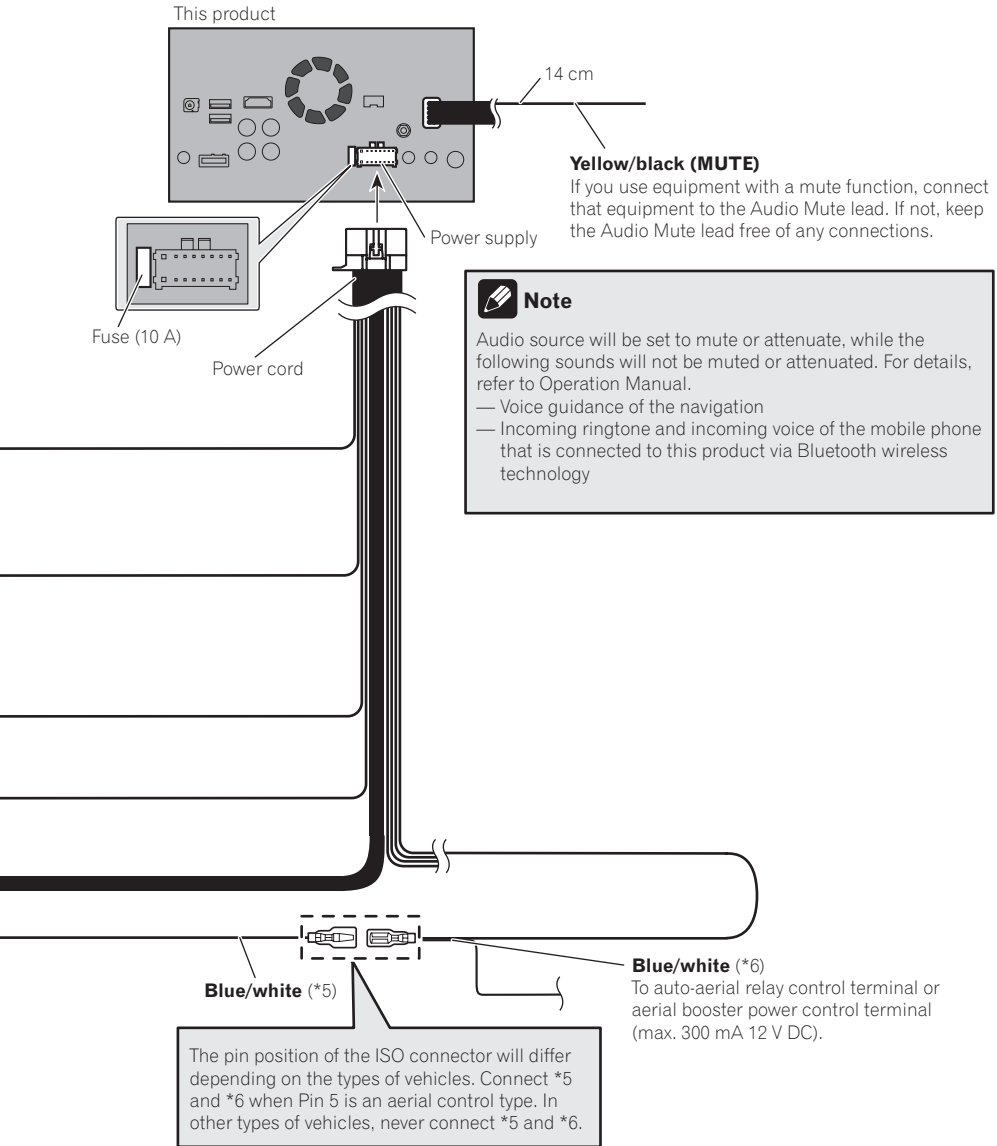

Connecting the power cord (2)



Pink (CAR SPEED SIGNAL INPUT)

This product is connected here to detect the distance the vehicle travels. Always connect the vehicle's speed detection circuit. Failure to make this connection will increase errors in the vehicle's location display.



WARNING

IMPROPER CONNECTION MAY RESULT IN SERIOUS DAMAGE OR INJURY INCLUDING ELECTRICAL SHOCK, AND INTERFERENCE WITH THE OPERATION OF THE VEHICLE'S ANTILOCK BRAKING SYSTEM, AUTOMATIC GEARBOX AND SPEEDOMETER INDICATION.



CAUTION

It is strongly suggested that the speed pulse wire be connected for accuracy of navigation and better performance.



Note

The position of the speed detection circuit and the position of the handbrake switch vary depending on the vehicle model. For details, consult your authorised Pioneer dealer or an installation professional.

Light green (PARKING BRAKE)

Used to detect the ON/OFF status of the handbrake. This lead must be connected to the power supply side of the handbrake switch.

If this connection is made incorrectly or omitted, certain functions of this product will be unusable.



WARNING

LIGHT GREEN LEAD AT POWER CONNECTOR IS DESIGNED TO DETECT PARKED STATUS AND MUST BE CONNECTED TO THE POWER SUPPLY SIDE OF THE HANDBRAKE SWITCH. IMPROPER CONNECTION OR USE OF THIS LEAD MAY VIOLATE APPLICABLE LAW AND MAY RESULT IN SERIOUS INJURY OR DAMAGE.

Connection method



Clamp the lead of the power supply side of the handbrake switch.

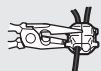

Clamp firmly with needle-nosed pliers.

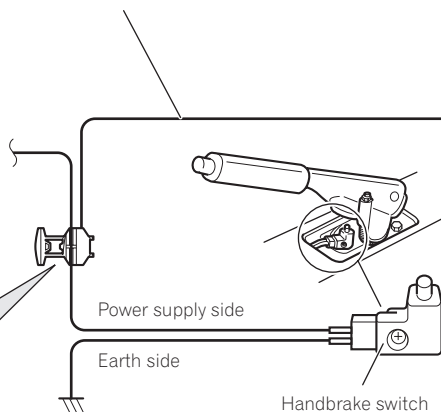

Connection

This product

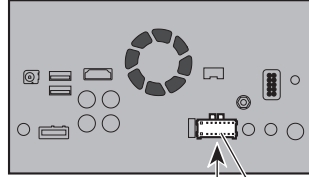

Power supply

Power cord

Violet/white (REVERSE-GEAR SIGNAL INPUT)

This is connected so that this product can detect whether the vehicle is moving forwards or backwards. Connect the violet/white lead to the lead whose voltage changes when the reverse gear is engaged. Unless connected, the sensor may not detect your vehicle travelling forward/backward properly, and thus the position of your vehicle detected by the sensor may be misaligned from the actual position.



Note

When you use a rear view camera, please make sure to connect this lead. Otherwise you cannot switch to the rear view camera picture.



Connecting the system

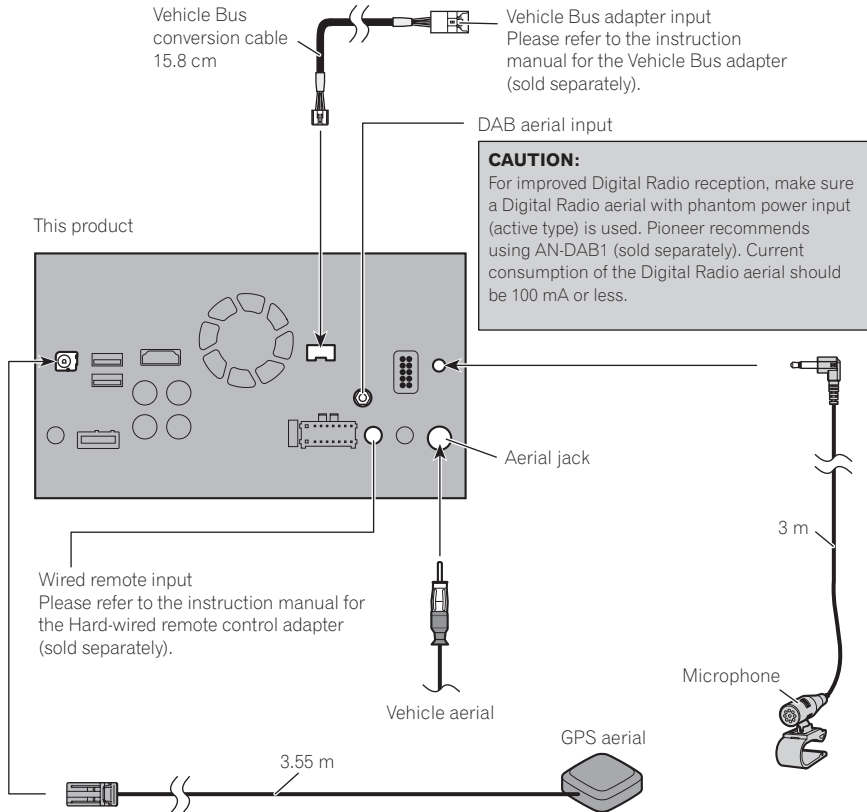

! WARNING

- To avoid the risk of accident and the potential violation of applicable laws, this product should never be used while the vehicle is being driven except for navigation purposes. And, also rear displays should not be in a location where it is a visible distraction to the driver.
- In some countries, the viewing of images on a display inside a vehicle even by persons other than the driver may be illegal. Where such regulations apply they must be obeyed and this product's video source should not be used.



Connection

Connecting to separately sold power amp

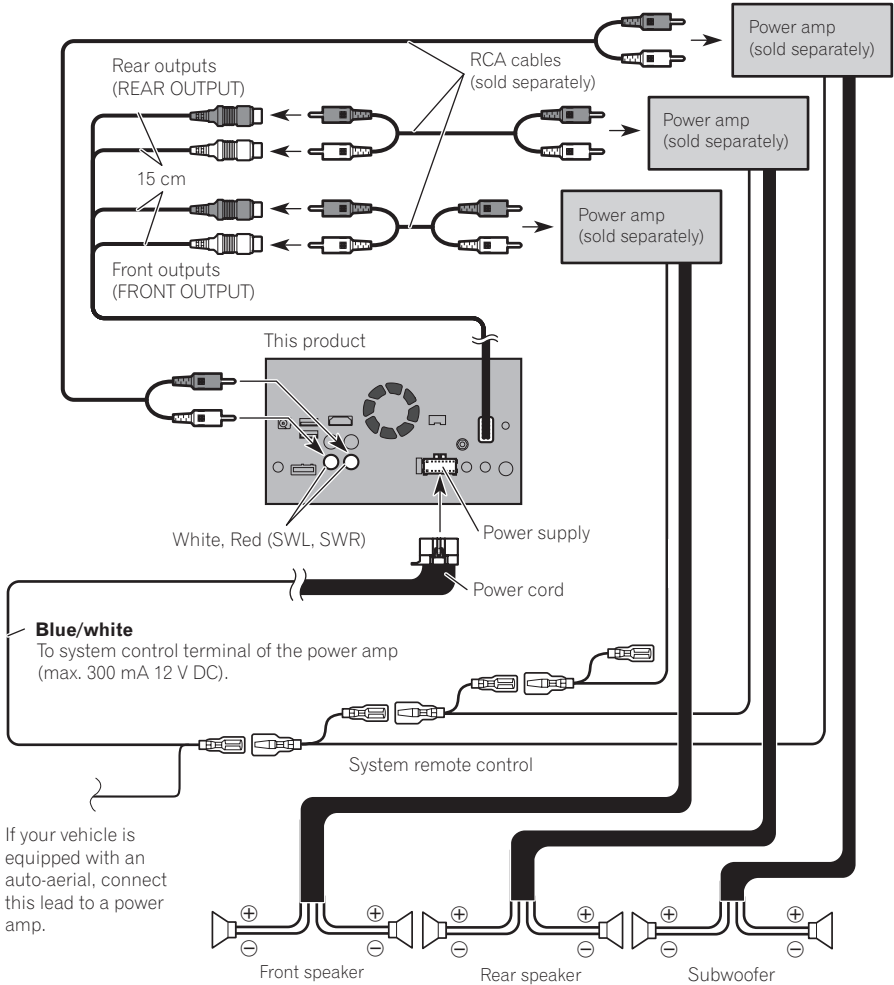

Notes

- You can change the RCA output of the subwoofer depending on your subwoofer system. (Refer to Operation Manual.)
- The subwoofer output of this product is monaural.



Connecting an iPod / iPhone or an Android device

Find your device and the function you want to operate from the list below, and refer to the page for the connection.

□ Depending on the device, some functions may not be available.

iPhone (5, 5c, 5s, 6, 6 Plus)/iPod touch (5th generation)

iPod (audio)

Apple CarPlay

Pandora

AVICSYNC App

Refer to *Connecting via the USB port (iPhone)* on page 15.

AppRadio Mode

Pandora

AVICSYNC App

Refer to *Connecting via the HDMI port (iPhone)* on page 15.

iPhone 3GS/iPod touch (2nd, 3rd generation)/iPod classic (80GB, 160GB)/iPod nano (3rd, 4th, 5th, 6th generation)

iPod (audio)

iPod (video)

Pandora

Refer to *Connecting via the AUX input (iPhone)* on page 16.

iPhone (4, 4s)/iPod touch (4th generation)

iPod (audio)

iPod (video)

AppRadio Mode

Pandora

AVICSYNC App

Refer to *Connecting via the RGB input (iPhone)* on page 16.

iPod nano (7th generation)

iPod (audio)

Refer to *Connecting via the USB port (iPhone)* on page 15.

Android device

AppRadio Mode

Pandora

AVICSYNC App

HDMI port

Refer to *Connecting via the HDMI port (Android device)* on page 17.

MHL port

Refer to *Connecting via the MHL port (Android device)* on page 17.

F80DAB

Android Auto

Pandora

AVICSYNC App

Refer to *Connecting via the USB port (Android device)* on page 18.



Connection

Connecting an iPhone with Lightning connector

Notes

- For details on how to connect an external device using a separately sold cable, refer to the manual for the cable.
- For details concerning the connection, operations and compatibility of iPhone, refer to Operation Manual.

Connecting via the USB port (iPhone)

The USB interface cable for iPod / iPhone (CD-IU52) (sold separately) is required for the connection.

- When using **Apple CarPlay**, connect the iPhone to USB port 1.

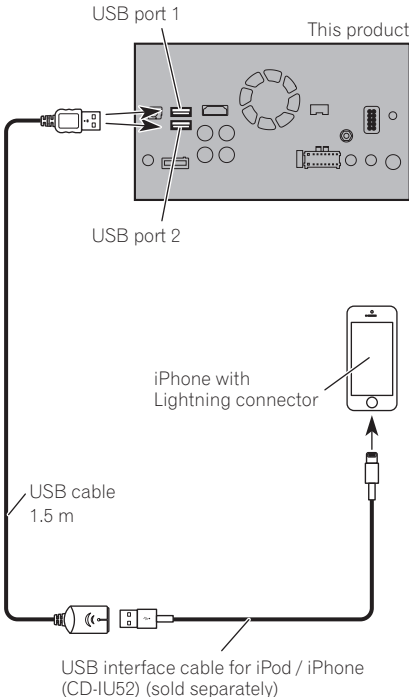

Connecting via the HDMI port (iPhone)

The following cables are required for the connection.

- HDMI interface cable for iPod / iPhone (CD-IH202) (sold separately)
- USB interface cable for iPod / iPhone (CD-IU52) (sold separately)
- Lightning Digital AV Adapter (Apple Inc. products) (sold separately)

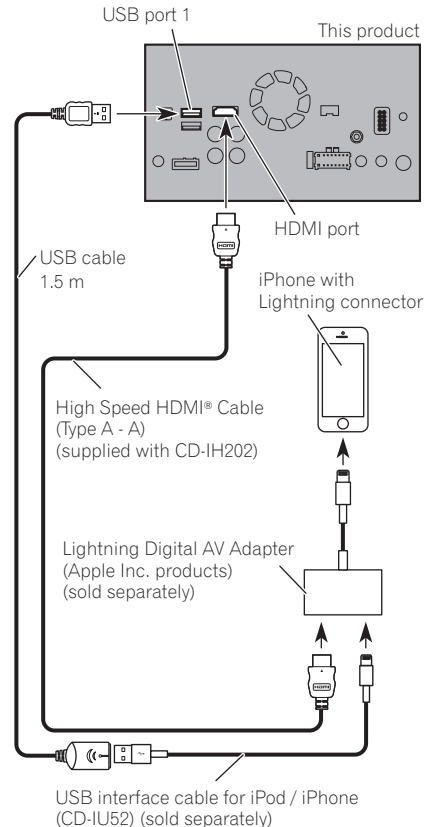

Note

When you connect the High Speed HDMI® Cable, use the lock tie to fix it securely.

- ➡ For details, refer to *Securing the High Speed HDMI® Cable* on page 18. 

Connecting an iPhone with 30-pin connector



Notes

- For details on how to connect an external device using a separately sold cable, refer to the manual for the cable.
- For details concerning the connection, operations and compatibility of iPhone, refer to Operation Manual.

Connecting via the AUX input (iPhone)

The USB interface cable for iPod / iPhone (CD-IU201V) (sold separately) is required for the connection.

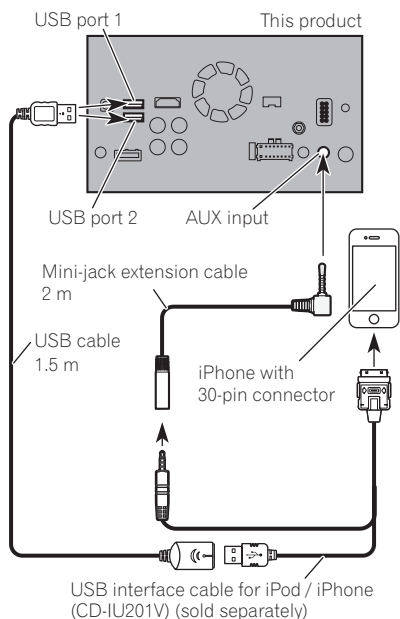

Connecting via the RGB input (iPhone)

The USB interface cable for iPod / iPhone (CD-IU201S) (sold separately) is required for the connection.

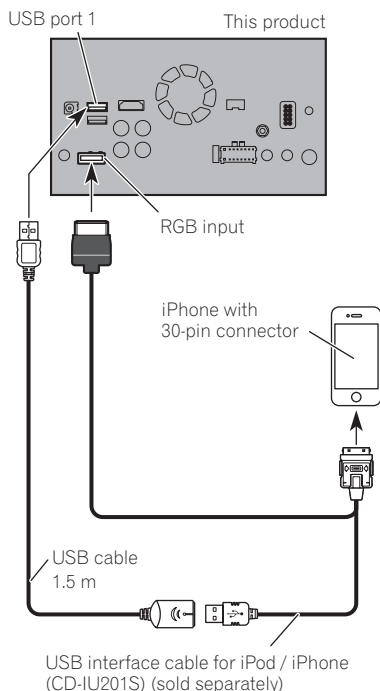

Note

Connect the USB cable to USB port 1 when using "Pandora" as the source.

Connection

Connecting the Android™ device

App Connectivity Kit (CD-AH200) (sold separately) is required for the connection.

Notes

- For details on how to connect an external device using a separately sold cable, refer to the manual for the cable.
- For details concerning the connection and operations of Android device, refer to Operation Manual.
- When you connect the High Speed HDMI® Cable, use the lock tie to fix it securely.
 - ➔ For details, refer to *Securing the High Speed HDMI® Cable* on page 18.

Connecting via the HDMI port (Android device)

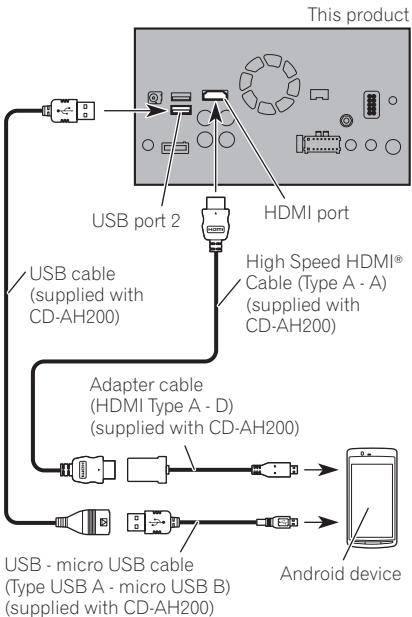

Connecting via the MHL port (Android device)

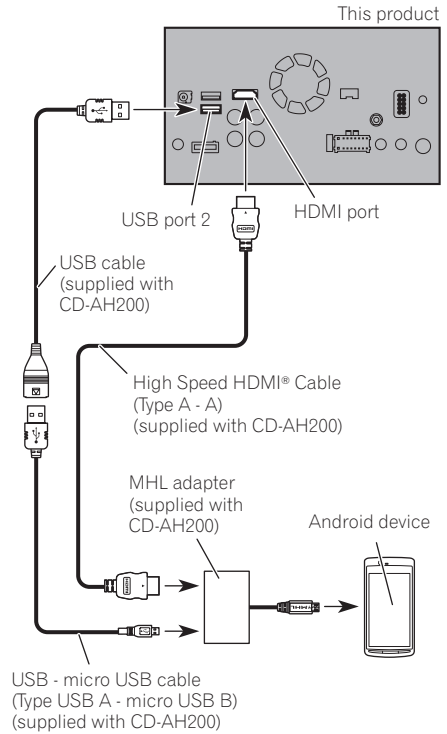

Connecting via the USB port (Android device)

The USB interface cable for use with Android devices (CD-MU200) (sold separately) is required for the connection.

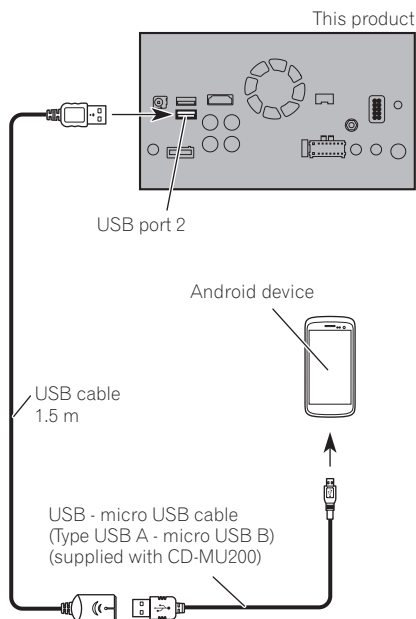

Note

For details on how to connect an external device using a separately sold cable, refer to the manual for the cable.

Securing the High Speed HDMI® Cable

Be sure to fix the High Speed HDMI® Cable with the lock tie, when you connect the external device with the High Speed HDMI® Cable.

1 Insert the High Speed HDMI® Cable into the HDMI port.

2 Wrap the lock tie around the hook above the HDMI port and the High Speed HDMI® Cable, and then tighten it to secure the High Speed HDMI® Cable.

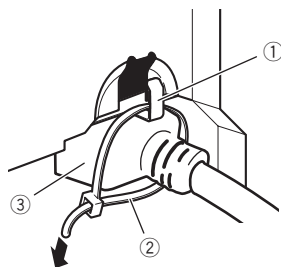

- ① Hook
 - ② Lock tie
 - ③ High Speed HDMI® Cable
- Do not tighten up the lock tie more than necessary.

Connection

Connecting a rear view camera

When this product is used with a rear view camera, it is possible to automatically switch from the video to rear view image when the gearstick is moved to **REVERSE (R)**. **Camera View** mode also allows you to check what is behind you while driving.



WARNING

USE INPUT ONLY FOR REVERSE OR MIRROR IMAGE REAR VIEW CAMERA. OTHER USE MAY RESULT IN INJURY OR DAMAGE.



CAUTION

- The screen image may appear reversed.
- The rear view camera is used as an aid to keep an eye on trailers, or backing into a tight parking spot. Do not use this function for entertainment purposes.
- Objects in rear view may appear closer or more distant than in reality.
- Please note that the image area shown by the rear view camera may differ slightly when full-screen images are displayed when backing and when checking the rear of the vehicle while moving forward.

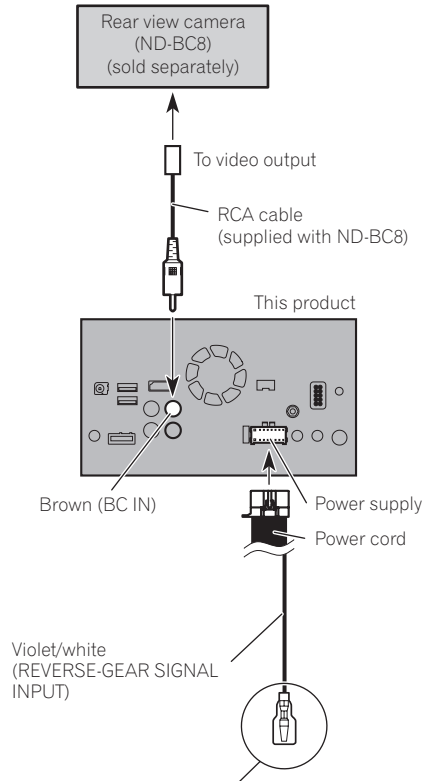

For more details about the wiring, refer to *Connecting the power cord (2)* on page 10.



Notes

- This mode is available when the rear view camera setting is set to "On". (For details, refer to Operation Manual.)
- Connect this product to the rear view camera only. Do not connect to any other equipment. ▣

Connecting the external video component

Using AV input

You can connect an external video component or external camera to this product.

Connecting an external camera

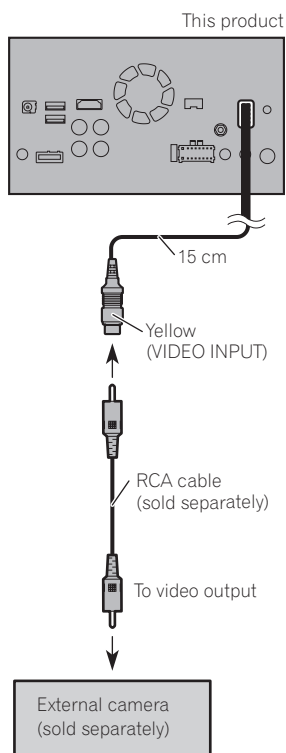

Note

This mode is available when the setting of AV input is set to "Camera". (For details, refer to Operation Manual.)

Connecting the video component

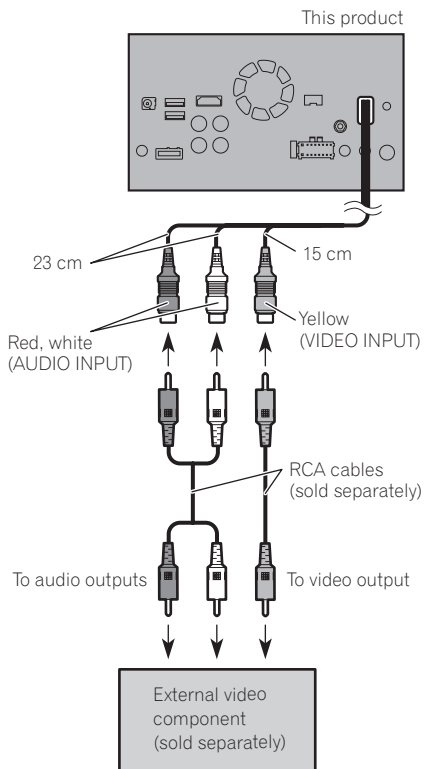

Note

This mode is available when the setting of AV input is set to "Source". (For details, refer to Operation Manual.)

Connection

Using an AUX input

This product

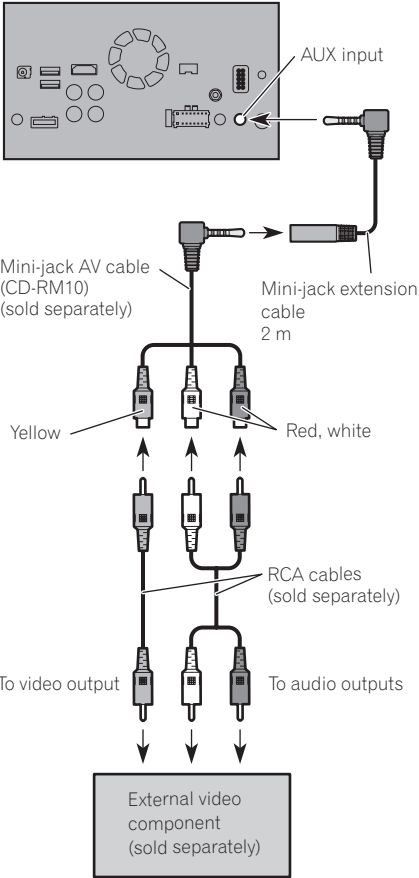

⚠ CAUTION

Be sure to use a mini-jack AV cable (CD-RM10) (sold separately) for wiring. If you use other cables, the wiring position might differ resulting in disturbed images and sounds.

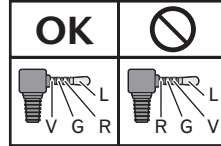

L : Left audio (White)
 R : Right audio (Red)
 V : Video (Yellow)
 G : Earth

✎ Notes

- This mode is available when the setting of AUX input is set to "On". (For details, refer to Operation Manual.)
- When connecting an external video component using a mini-jack AV cable, use a separately sold AUX extension cable as necessary.

Connecting an HDMI device

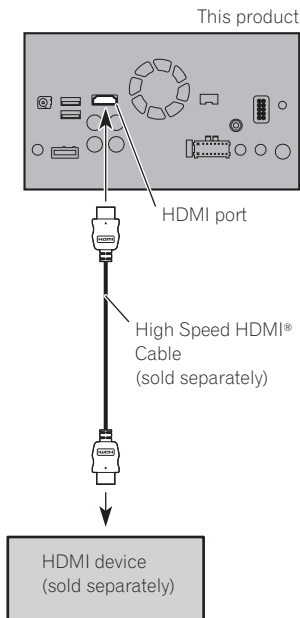

Notes

- For details concerning the operations of HDMI device, refer to Operation Manual.
- When you connect the High Speed HDMI® Cable, use the lock tie to fix it securely.
- ➔ For details, refer to *Securing the High Speed HDMI® Cable* on page 18. 

Connecting the rear display

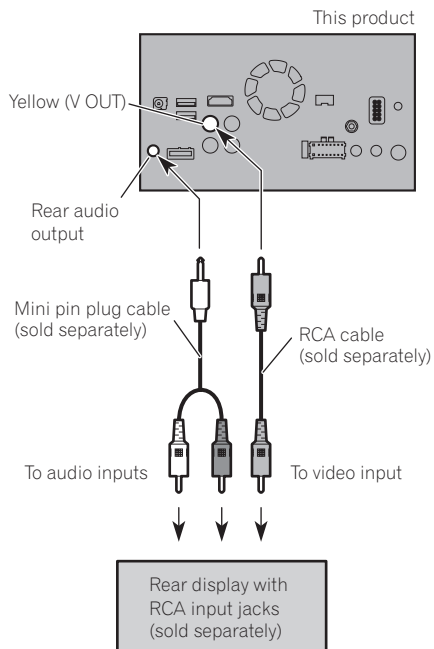

When using a rear display connected to rear video output



WARNING

NEVER install the rear display in a location that enables the driver to watch the video source while driving.

This product's rear video output is for connection of a display to enable passengers in the rear seats to watch the video source. 

Precautions before installation

CAUTION

- Never install this product in places where, or in a manner that:
 - Could injure the driver or passengers if the vehicle stops suddenly.
 - May interfere with the driver's operation of the vehicle, such as on the floor in front of the driver's seat, or close to the steering wheel or gearstick.
- Make sure there is nothing behind the dashboard or panelling when drilling holes in them. Be careful not to damage fuel lines, brake lines, electronic components, communication wires or power cables.
- When using screws, do not allow them to come into contact with any electrical lead. Vibration may damage wires or insulation, leading to a short circuit or other damage to the vehicle.
- To ensure proper installation, be sure to use the supplied parts in the manner specified. If any parts are not supplied with this product, use compatible parts in the manner specified after you have the parts' compatibility checked by your dealer. If parts other than supplied or compatible ones are used, they may damage internal parts of this product or they may work loose and the product may become detached.
- It is extremely dangerous to allow cables to become wound around the steering column or gearstick. Be sure to install this product, its cables, and wiring away in such so that they will not obstruct or hinder driving.
- Make sure that leads cannot get caught in a door or the sliding mechanism of a seat, resulting in a short circuit.
- Please confirm the proper function of your vehicle's other equipment after installation of this product.
- Do not install this product where it may (i) obstruct the driver's vision, (ii) impair the performance of any of the vehicle's operating systems or safety features, including airbags, hazard lamp buttons or (iii) impair the driver's ability to safely operate the vehicle.
- Install this product between the driver's seat and front passenger seat so that it will not be hit by the driver or passenger if the vehicle stops quickly.
- Never install this product in front of or next to the place in the dashboard, door, or pillar from which one of your vehicle's airbags would deploy. Please refer to your vehicle's owner's manual for reference to the deployment area of the frontal airbags.
- Failure to follow all of these precautions may result in serious injury or death. 

To avoid electromagnetic interference

In order to prevent interference, set the following items as far as possible from this product, other cables or leads:

- FM, AM aerial and its lead
- DAB aerial and its lead
- GPS aerial and its lead

In addition, you should lay or route each aerial lead as far as possible from other aerial leads. Do not bind, lay or route them together, or cross them. Electromagnetic noise will increase the potential for errors in the vehicle's location display. 

Before installing

- Consult with your nearest dealer if installation requires drilling holes or other modifications of the vehicle.

- Before making a final installation of this product, temporarily connect the wiring to confirm that the connections are correct and the system works properly.

For AVIC-F80DAB users

Do not install this product in a position where the opening of the LCD panel is obstructed by any obstacles, such as the gearstick. Before installing this product, be sure to leave sufficient space so that the LCD panel does not obstruct the gearstick when it is fully opened. This may cause interference with the gearstick, or a malfunction of the mechanism of this product. ▣

Installing this product

Installation notes

- Do not install this product in places subject to high temperatures or humidity, such as:
 - Places close to a heater, vent or air conditioner.
 - Places exposed to direct sunlight, such as on top of the dashboard.
 - Places that may be exposed to rain, such as close to the door or on the vehicle's floor.
- Install this product in an area strong enough to bear its weight. Choose a position where this product can be firmly installed, and install it securely. If this product is not securely installed, the current location of the vehicle cannot be displayed correctly.
- Install this product horizontally on a surface within 0 to 30 degrees tolerance (within 5 degrees to the left or right). Improper installation of the product with the surface tilted more than these tolerances increases the potential for errors in the vehicle's location display, and might otherwise cause reduced display performance.
- When installing, to ensure proper heat dispersal when using this product, make sure you leave ample space behind the rear panel and wrap any loose cables so they are not blocking the vents.

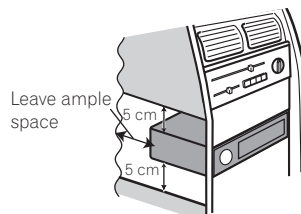
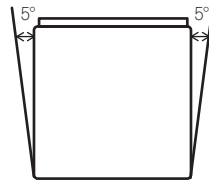
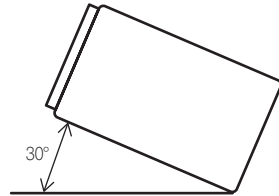

Installation

- The cords must not cover the area shown in the figure below. This is necessary to allow the amps and navigation mechanism to dissipate heat.

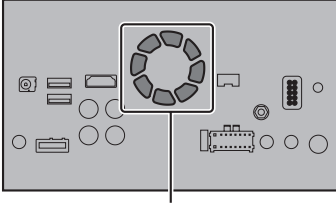

Do not cover this area.

- The semiconductor laser will be damaged if it overheats, so don't install this product anywhere hot — for instance, near a heater outlet.

Parts supplied

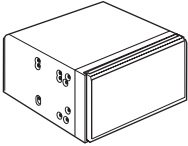

This product



Truss head screw
(5 mm × 8 mm)
(6 pcs.)



Flush surface screw
(5 mm × 9 mm)
(6 pcs.)

et, and tighten the screws at three locations on each side.

Use either the truss head screws (5 mm × 8 mm) or flush surface screws (5 mm × 9 mm), depending on the shape of the bracket's screw holes.

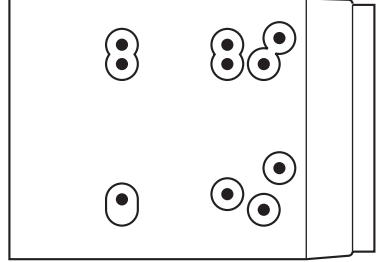

If the pawl interferes with installation, you may bend it down out of the way.

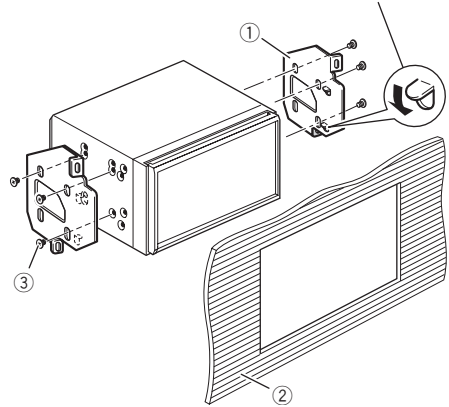

- Factory radio-mounting bracket
 - Dashboard or console
 - Truss head screw or flush surface screw
- Be sure to use the screws supplied with this product. ▣

Installation using the screw holes on the side of this product

- Fastening this product to the factory radio-mounting bracket.**

Position this product so that its screw holes are aligned with the screw holes of the bracket,

Installing the GPS aerial

! CAUTION

Do not cut the GPS aerial lead to shorten it or use an extension to make it longer. Altering the aerial cable could result in a short circuit or malfunction and permanent damage to this product.

Installation notes

- The aerial should be installed on a level surface where radio waves will be blocked as little as possible. Radio waves cannot be received by the aerial if reception from the satellite is blocked.

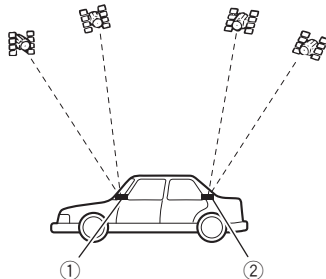

- ① Dashboard
- ② Rear shelf

- When installing the GPS aerial inside the vehicle, be sure to use the metal sheet provided with your system. If this is not used, the reception sensitivity will be poor.
- Do not cut the accessory metal sheet. This would reduce the sensitivity of the GPS aerial.
- Take care not to pull the aerial lead when removing the GPS aerial. The lead may become detached.
- Do not paint the GPS aerial, as this may affect its performance.

Installation

When installing the aerial inside the vehicle (on the dashboard or rear shelf)

⚠ WARNING

Do not install the GPS aerial over any sensors or vents on the dashboard of the vehicle, as doing so may interfere with the proper functioning of such sensors or vents and may compromise the ability of the metal sheet under the GPS aerial to properly and securely affix to the dashboard.

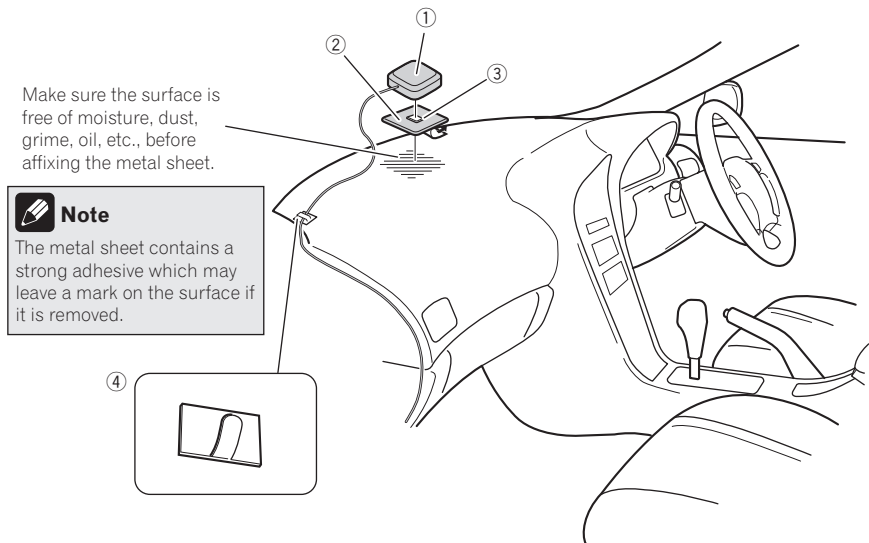

- ① GPS aerial
- ② Metal sheet
Peel off the protective sheet on the rear.
- ③ Double-sided tape
- ④ Clamps
Use clamps to secure the lead where necessary inside the vehicle.

Affix the metal sheet on the surface as level as possible where the GPS aerial faces the window. Affix the GPS aerial on the metal sheet using the double-sided tape.

✎ Notes

- When attaching the metal sheet, do not cut it into small pieces.
- Some models use window glass that does not allow signals from GPS satellites to pass through. On such models, install the GPS aerial on the outside of the vehicle.



Installing the microphone

- Install the microphone in a place where its direction and distance from the driver make it easiest to pick up the driver's voice.
- Be sure to turn off (ACC OFF) the product before connecting the microphone.
- Depending on the vehicle model, the microphone cable length may be too short when you mount the microphone on the sun visor. In such cases, install the microphone on the steering column.

Parts supplied

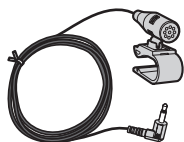

Microphone



Double-sided tape

Mounting on the sun visor

1 Fit the microphone lead into the groove.

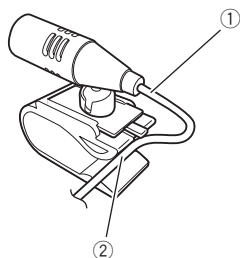

- ① Microphone lead
- ② Groove

2 Attach the microphone clip to the sun visor.

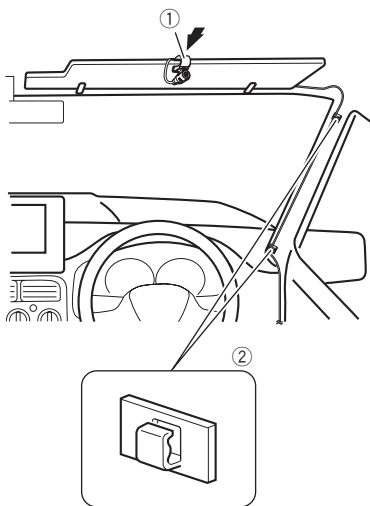

- ① Microphone clip
- ② Clamps

Use separately sold clamps to secure the lead where necessary inside the vehicle.

Install the microphone on the sun visor when it is in the up position. It cannot recognise the driver's voice if the sun visor is in the down position.

Installation

Installation on the steering column

1 Detach the microphone base from the microphone clip by sliding the microphone base while pressing the tab.

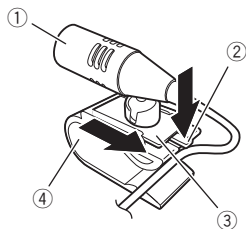

- ① Microphone
- ② Tab
- ③ Microphone base
- ④ Microphone clip

2 Mount the microphone on the steering column.

Install the microphone on the steering column, keeping it away from the steering wheel.

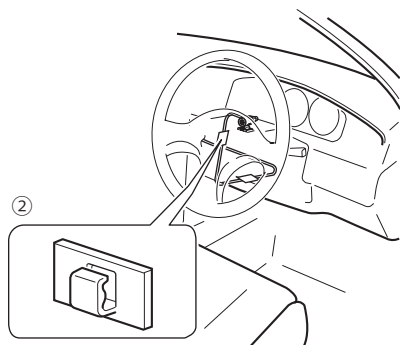
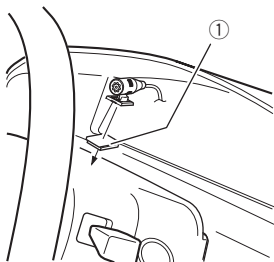

① Double-sided tape

② Clamps

Use separately sold clamps to secure the lead where necessary inside the vehicle.

Adjusting the microphone angle

The microphone angle can be adjusted.



After installing this product

1 Reconnect the negative (-) terminal of the vehicle's battery.

First, double-check that all connections are correct and that this product is installed correctly. Reassemble all vehicle components that you previously removed. Then reconnect the negative (-) cable to the negative (-) terminal of the battery.

2 Start the engine.

3 Press the RESET button.

Press the **RESET** button on this product with a pointed object such as the tip of a pen.

F80DAB

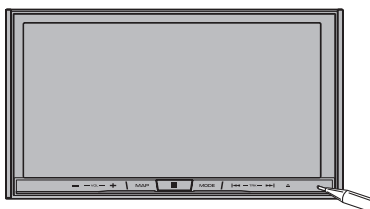

F980DAB

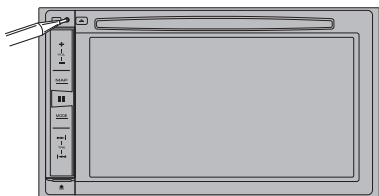

- Some of the settings and recorded contents will not be reset.

4 Change the settings as desired.

- ➔ For details concerning operations, refer to Operation Manual.

5 Drive down an unobstructed road until the GPS starts receiving the signal normally.



Note

After installing this product, be sure to check at a safe place that the vehicle is performing normally.

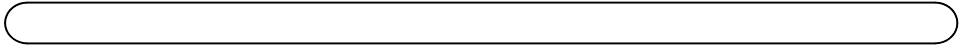

PIONEER CORPORATION

1-1, Shin-ogura, Saiwai-ku, Kawasaki-shi,
Kanagawa 212-0031, JAPAN

PIONEER ELECTRONICS AUSTRALIA PTY. LTD.

5 Arco Lane, Heatherton, Victoria, 3202, Australia
TEL: (03) 9586-6300

PIONEER ELECTRONICS (USA) INC.

P.O. Box 1540, Long Beach, California 90801-1540, U.S.A.
TEL: (800) 421-1404

PIONEER EUROPE NV

Haven 1087, Keetberglaan 1, B-9120 Melsele, Belgium/Belgique
TEL: (0) 3/570.05.11

PIONEER ELECTRONICS ASIACENTRE PTE. LTD.

2 Jalan Kilang Barat, #07-01, Singapore 159346
TEL: 65-6378-7888

PIONEER ELECTRONICS OF CANADA, INC.

340 Ferrier Street, Unit 2, Markham, Ontario L3R 2Z5, Canada
TEL: 1-877-283-5901
TEL: 905-479-4411

PIONEER ELECTRONICS DE MEXICO S.A. de C.V.

Bldv.Manuel Avila Camacho 138 10 piso
Col.Lomas de Chapultepec, Mexico, D.F. 11000
TEL: 52-55-9178-4270
FAX: 52-55-5202-3714

先鋒股份有限公司

台北市內湖區瑞光路407號8樓
電話：886-(0)2-2657-3588

先鋒電子（香港）有限公司

香港九龍長沙灣道909號5樓
電話：852-2848-6488

©2016 PIONEER CORPORATION.
All rights reserved.